

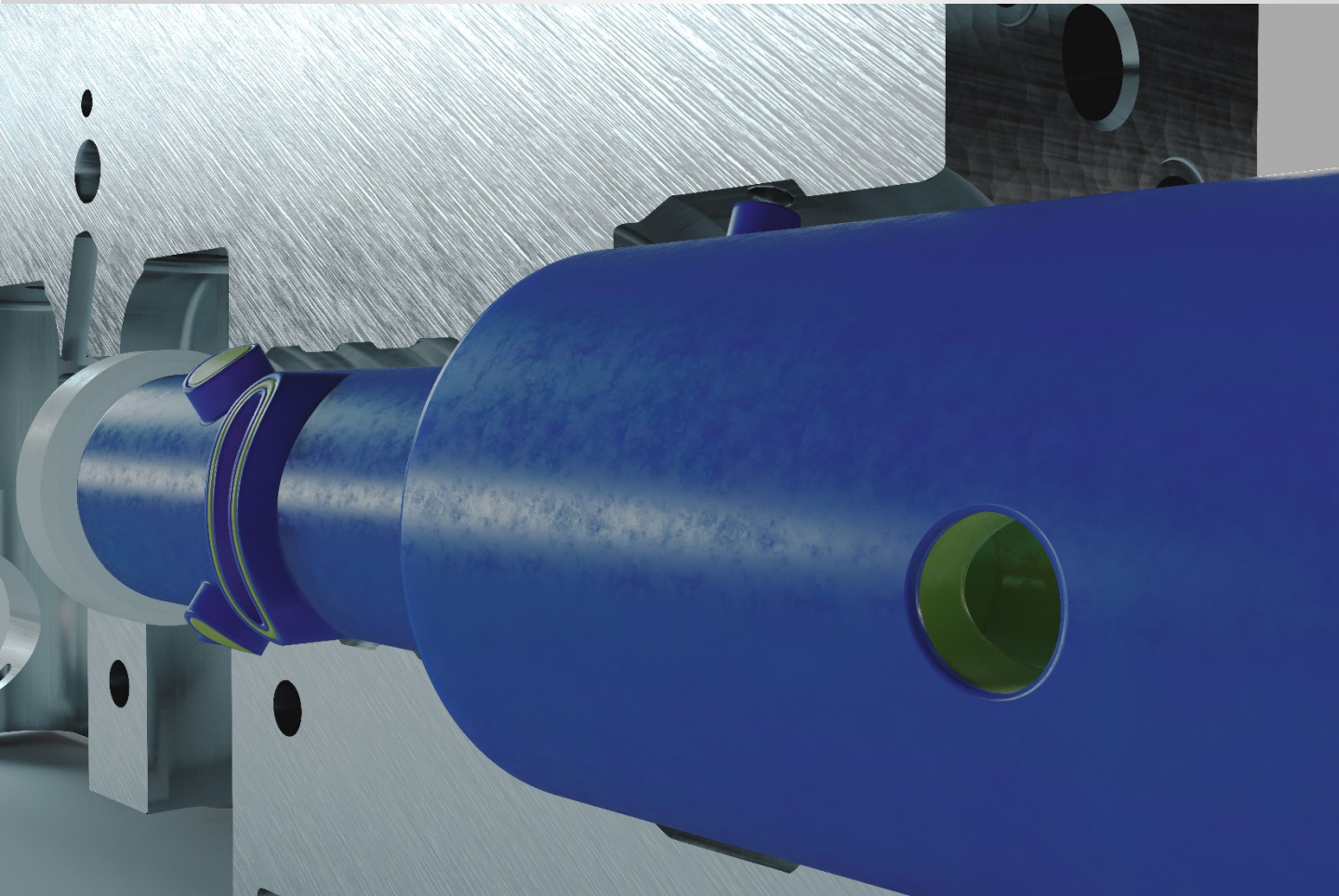

EXTRUDE  
HONE®

SHAPING YOUR FUTURE

Electrochemical (ECM) Applications by Extrude Hone





EXTRUDE  
HONE®

# Electrochemical (ECM) Applications by Extrude Hone

## Designed by us

Extrude Hone has been in business since the 1960s, building on its proprietary technology of extrude-honing. Along the way, other technologies joined the portfolio offering, like Electrochemical Machining (ECM). We design and manufacture machines and tooling and ensure support worldwide.

## We are proudly contributing to making Deburring and radiusing more productive.

**Electrochemical machining (ECM)** is a method of removing metal by an electrochemical process. It is often characterized as reverse electroplating because it removes material instead of adding it. ECM suits mass production, where conventional machining is not easy or economical. Be it difficult to reach areas or difficult to machine material, ECM has been fulfilling these requirements across industry-segments, for decades.

Though its use is limited to electrically conductive materials, ECM can do quite a few different things with relative ease and economy. That's what makes ECM a popular choice even in the present time. Extrude Hone design and build machines and tooling and ensure support worldwide.



Source ZF

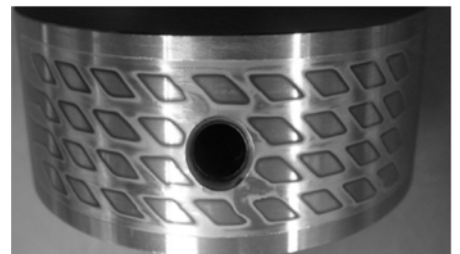



# The Applications in a nutshell

Electrochemical machining is a process that removes burrs and creates shapes like a radius or round edges by dissolving the material.

The process fits volume production or parts with demanding and multiple edges conditions to be achieved at once, like a hydraulic aerospace manifold.

The OEMs design super high-performance systems and components, some working under very high pressure. In some cases, it becomes far too difficult, or even impossible, to finish them by manually. Areas to be processed might be out of reach for manual tools, or too precise geometries to achieve even for the best-skilled workers. ECM can help finish multiple areas at once.

It can combine simple deburring or advanced edge shaping within the same part. ECM can also produce several parts per cycle, depending on the complexity of the operation and the size of the workpiece. The time cycle is usually between 30 seconds to 1 minute.

ECM delivers superior productivity while ensuring state-of-the-art quality with 100% consistency.

ECM applications are present in various industries, such as: automotive, medical, aerospace, energy / fluidic, and general engineering.



Source: Dassault Aviation

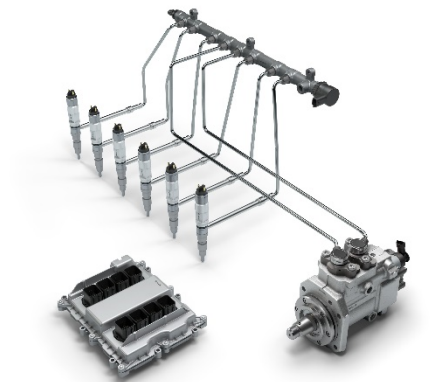

Source Bosch



Source ZF



EXTRUDE  
HONE®

# Edge and Surface matter, ECM Capabilities as well.

## Extrude Hone ECM finishing methods

Depending on your finishing requirements, the component geometry, the material, and the machining process, we have solutions.

### ECM deburring or ECD

Simple burr removal applications

### ECM radiusing

It's often combined with ECD to create a round edge, a true radius, or a chamfer.

### ECM Cavity machining

It creates an inner cavity of a specific shape deep inside a workpiece from a simple straight bore. Recessed forms are no longer hard to machine, and they come free of burrs and stress.

### ECM drilling

A dream comes true. An oval-shaped hole is an easy task for ECM.

### ECM Surface Structuring

Structuring a surface can be achieved with ECM. As an example, to better retain oil at a bearing surface.

### ECM Rifling

Rifling gets better when done using ECM (Static or Dynamic), no burrs, no mechanical machining stress applied, increased quality and precision.

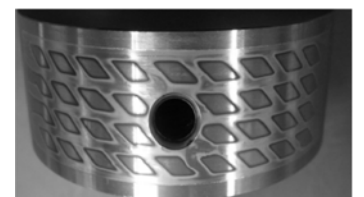



EXTRUDE  
HONE®

## ECM Pros and Cons

### The Pros

- Material removal at precisely defined locations.
- Suitable for machining hard-to-reach locations.
- Equally effective for metals that are difficult to machine.
- No mechanical or thermal stress applied to the workpiece.
- Roughing and finishing in one pass.
- High productivity.
- Multiple processes can be done in one cycle.
- No burrs generated. Practically no tool wear.
- Superior process stability and process control.
- Possibility to use fixtures ( set of cathodes managed for automatic positioning IN and OUT the workpiece) or Flexi-cathodes ( positioning by hand or by a robot).

### The Cons

- Only applicable to electrically-conductive materials
- Post-process treatment required due to corrosive salts Requires dedicated tooling, as the cathode needs to match the workpiece design to be machined.





# When ECM scores over conventional machining

ECM is preferred over conventional processes when it can not meet productivity & quality demands. The situation occurs when:

- Production volume is high
- Material is hard to machine
- Areas to be machined are difficult to reach
- Conventional machining is more expensive
- Conventional processes are not consistent in producing quality output

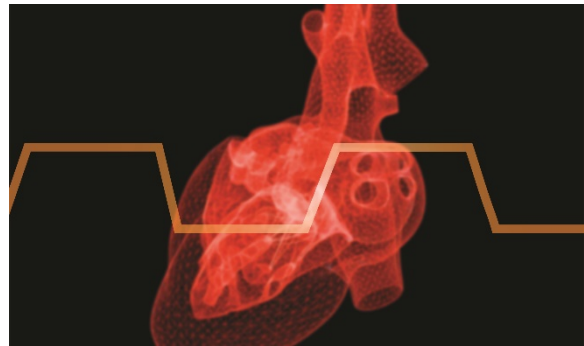

Some of ECM’s inherent characteristics make it well-suited in modern-day manufacturing, involving exotic materials, intricate shapes, and high productivity & quality demands.

ECM characteristics	The value it adds
<ul style="list-style-type: none"> <li>• ECM removes material by dissolving it.</li> </ul>	<ul style="list-style-type: none"> <li>• The physical properties of material do not affect ECM. ECM is equally effective for hardened materials.</li> <li>• Machining happens at room temperature</li> <li>• The outcome of EC machining will be:               <ul style="list-style-type: none"> <li>- Free from burrs &amp; sharp edges</li> <li>- Free from thermal or mechanical stresses</li> </ul> </li> </ul>
<ul style="list-style-type: none"> <li>• In ECM, the tool removes material without coming in contact with the workpiece.</li> </ul>	<ul style="list-style-type: none"> <li>• No tool marks or broken tools</li> <li>• Theoretically, infinite tool life</li> </ul>



EXTRUDE  
HONE®

# The Science behind ECM

Faraday's law of electrolysis governs Electrochemical Machining (ECM), which states that the mass of a metal dissolved is proportional to the number of electrical charges transferred to the electrode:

$$m \propto Q \qquad m \propto I \times t \qquad m = C \times I \times t$$

Combining Ohm's law,  $V = I \times R$ , the equation becomes:

$$m = C \times (V / R) \times t$$

With:

$m$  = mass of material dissolved

$Q$  = amount of charge passed

$I$  = current

$t$  = time

$C$  = constant of proportionality

$V$  = voltage applied

$R$  = resistance

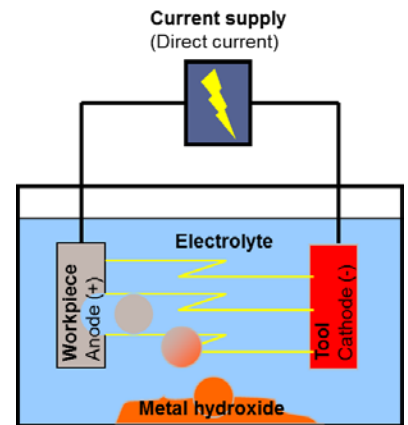

## Main elements involved in ECM

- A Direct Current power supply.
- Tool, connected to the (-) terminal of the power supply, the cathode.
- The workpiece, connected to the (+) terminal of the power supply, the anode.
- Electrolyte, filling up the gap between two electrodes.

When voltage applies across the electrodes, the current starts flowing thru' the electrolyte, dissolving material at the anode as per Faraday's principle, thereby creating defined edges and surfaces by mapping the cathode geometry in the work piece. The dissolved material forms corresponding metallic hydroxide and flows with the electrolyte.

This process happens at a molecular level, with low voltage, at room temperature, without adding mechanical or thermal stress to the material.

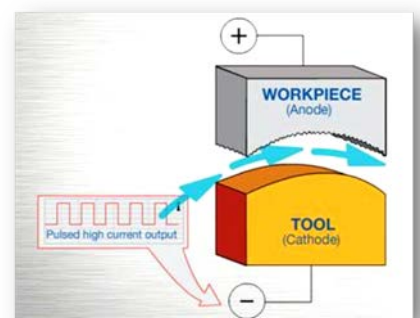



EXTRUDE  
HONE®

## What is the “Gap”

The entire ECM process occurs in the ‘gap’ between two electrodes. The gap is to be:

- Large enough to:
  - Avoid electrodes touching each other, resulting in short circuit.
  - Allow electrolyte to flow freely.
- But not too large to:
  - Transfer the electrical charge with a safe operating voltage.
  - Adversely affect critical areas of the component.

As material starts dissolving at the workpiece, the gap increases. Electrolyte flowing thru the gap carries away hydroxides and heat generated as the current passing thru’ the resistance.

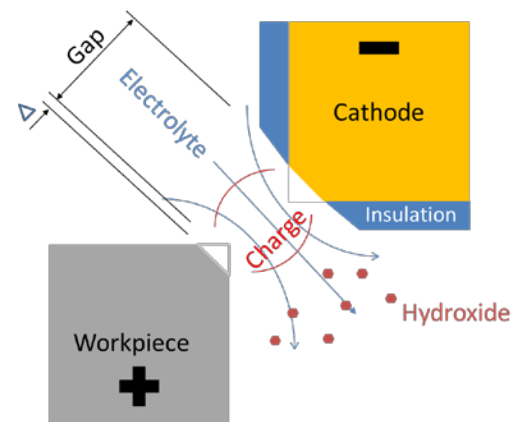





EXTRUDE  
HONE®

## The different type of ECM

	Static ECM	Dynamic ECM	Precise ECM
Basic principle	In static ECM, tool (cathode) & workpiece (anode) remains static.	In Dynamic ECM, cathode moves (combination of 1 or 2 axis movement) as ECM happens.	In Precise ECM, the gap between cathode and anode is much smaller than in static and dynamic ECMs. In this case, the cathode oscillates and moves as ECM happens.
Applications	<ul style="list-style-type: none"><li>▪ Deburring</li><li>▪ Edge radiusing</li><li>▪ Micro structuring</li><li>▪ Contour machining</li><li>▪ Rifling</li></ul>	<ul style="list-style-type: none"><li>▪ Drilling</li><li>▪ Shaping</li><li>▪ Rifling</li><li>▪ Broaching</li></ul>	<ul style="list-style-type: none"><li>▪ Shaping with high accuracy and surface finish.</li></ul>

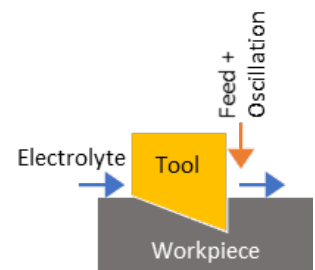
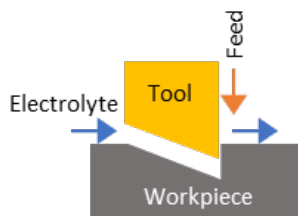
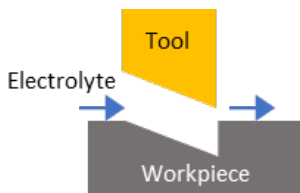



EXTRUDE  
HONE®

## What an ECM setup looks like

Any ECM machine needs to have the following elements for functioning.

- Electrolyte system:
  - Stores, conditions, and supplies electrolyte to ECM process.
- Generator:
  - Supplies DC voltage as per process requirements.
- Fixture:
  - Combines electrical contacts, component holding, and electrolyte flow passages.
- Controls:
  - Monitors and controls all factors that influence the ECM process.

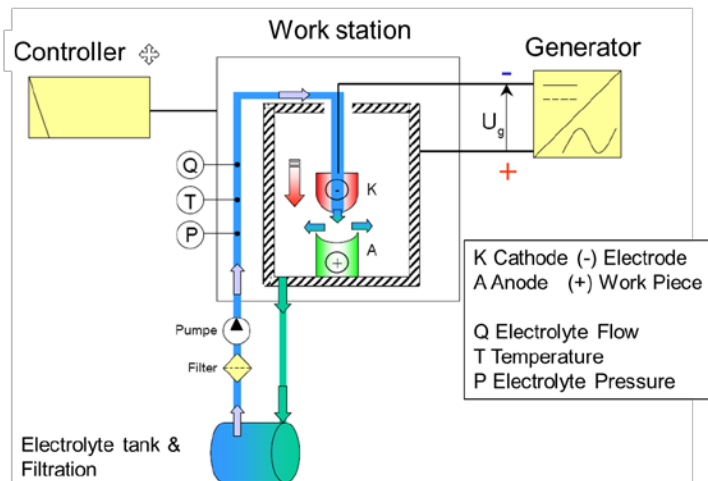



EXTRUDE  
HONE®

# ECM operating parameters

Any ECM machine keeps control of the below parameters:

- Current: different generators from 50 A to 4000A.
- Voltage: from 1 to 59 V ( or as an exception limited to 30V).
- Process times: mostly between 1 to 60 seconds.
- Electrolyte pressure
- pH
- Conductivity
- Filtration
- Monitoring of machine components

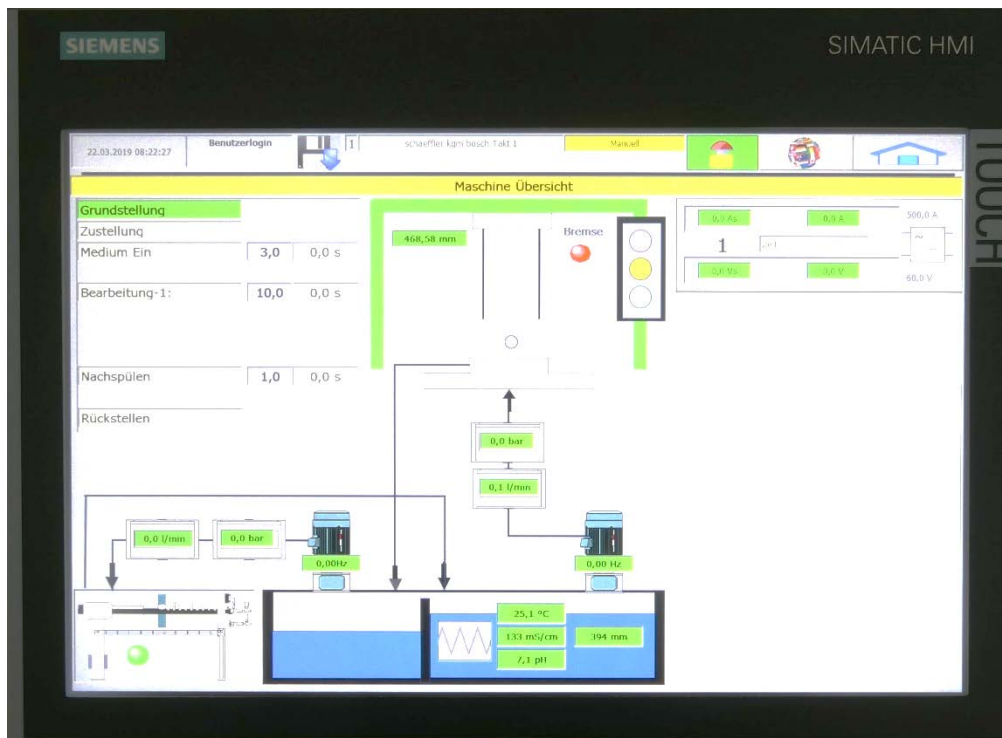



EXTRUDE  
HONE®

## Achieving consistency in ECM

Consistency is the hallmark of any process. When you produce thousands of components every day throughout the year, it is critical to ensure that all of them are all within the specification.

In the ECM process, consistency depends on a few different factors. Unless these factors are under precise control, the output quality is at risk.

Given the governing equation, **I** and **t** are to be under control to achieve consistent mass removal in every cycle. Where **C**, the constant of proportionality, is decided by the material being machined.

Now **I** depends on **V** and **R**. For an applied voltage, the amount of current flow across the gap depends on the resistance.

In an ECM machine, **V** and **t** are settable in the controller.

The challenge lies with **R**, which varies with a few other things. And the variation in any will have an impact on **I**, hence on **m**.

The most important factors controlling **R** are:

1. Conductivity of the electrolyte:
  - Salinity
  - Temperature
2. Gap between electrodes

$$m = C \times I \times t$$

$$m = C \times (V / R) \times t$$

### Correlation of factors

Salinity ↗

Resistance ↘

Temperature ↗

Resistance ↘

Gap ↗

Resistance ↗



EXTRUDE  
HONE®

# Temperature, Salinity and Conductivity of the electrolyte

Depending on the salt used, the conductivity of the electrolyte increase with the salinity and temperature of the electrolyte.

Higher the salinity and temperature, more material will be removed in the process for a given operating voltage and time.

If not monitored and controlled closely, temperature and salinity can affect ECM consistency significantly.

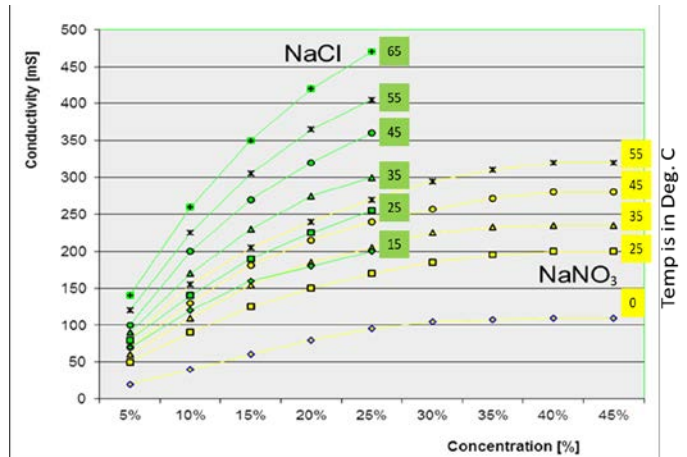

## Gap between electrodes

The initial stage of the fixture design and the feasibility trials will contribute to defining the gap between the electrodes. It depends on by the quality of incoming components and the requirements of the finished workpiece.

Smaller the gap is better for the ECM process because it offers lesser resistance to the current flow. The process then runs with minimum voltage. Also, the ECM effects will focus on targeted areas.

It is also essential to maintain consistency in the incoming workpiece quality to achieve consistency in the output quality.

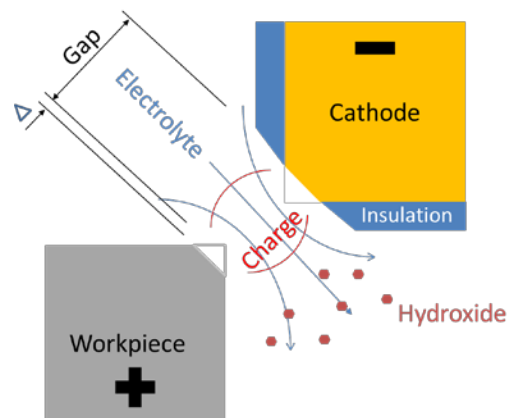



EXTRUDE  
HONE®

## Other factors that influence on ECM consistency

Among the other factors that influence ECM outcome, the main ones are:

- pH of the electrolyte
- Flow of electrolyte
- Pattern of the voltage applied
- Electrolyte cleanliness
- Pre and post ECM processing
- Consistency in input condition

## Electrolyte pH

In the ECM process, Hydrogen is liberated at the electrode, transforming the electrolyte to basic. The addition of a controlled dose of acid in the electrolyte tank keeps the desired pH. Dosing depends on the feedback received from pH sensors and setpoint entered in the controller.

Maintaining pH close to neutral is helpful to the operator and system. Moreover, for every material machined, there is a given pH range to maintain an efficient filtration of the electrolyte. And maintaining a clean electrolyte is key to the quality of ECM outcome, primarily surface finish and appearance.

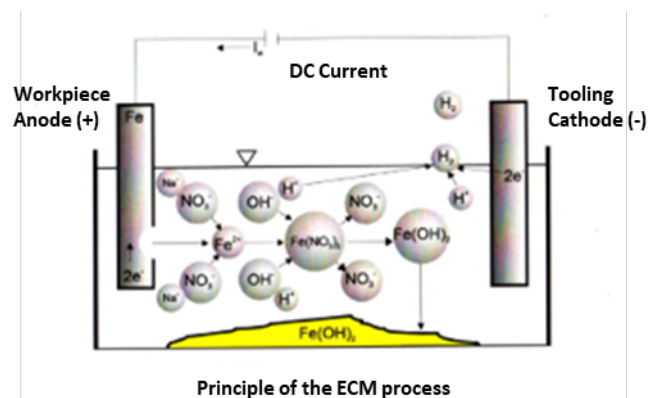



EXTRUDE  
HONE®

## Electrolyte flow

In the ECM process, the electrolyte in the gap is essential to carry an electrical charge and accomplish material removal. A controlled flow of the electrolyte ensures:

- Effective evacuation of hydroxide produced in ECM.
- Efficient transfer of the heat generated in the gap.
- The shape of the edge generated in ECM.
- The surface finish achieved in ECM

For better consistency of the process, the electrolyte flow must stay within a preset level. Pressure and flow controllers installed in the electrolyte circuit help achieve that goal.

## Electrolyte cleanliness

In the ECM process, the material removed consists of a metal hydroxide. It is carried away from the machining area by the flow of the electrolyte. And it needs to be filtered continuously to maintain electrolyte clean.

An unclean electrolyte has many adverse effects:

- Blocking the flow passages.
- Leaving deposits on the fixture.
- Deteriorating ECM quality in terms of surface finish and appearance.

An effective filtration system filters hydroxides while converting them into a cake-type material that is easy to handle and disposable.

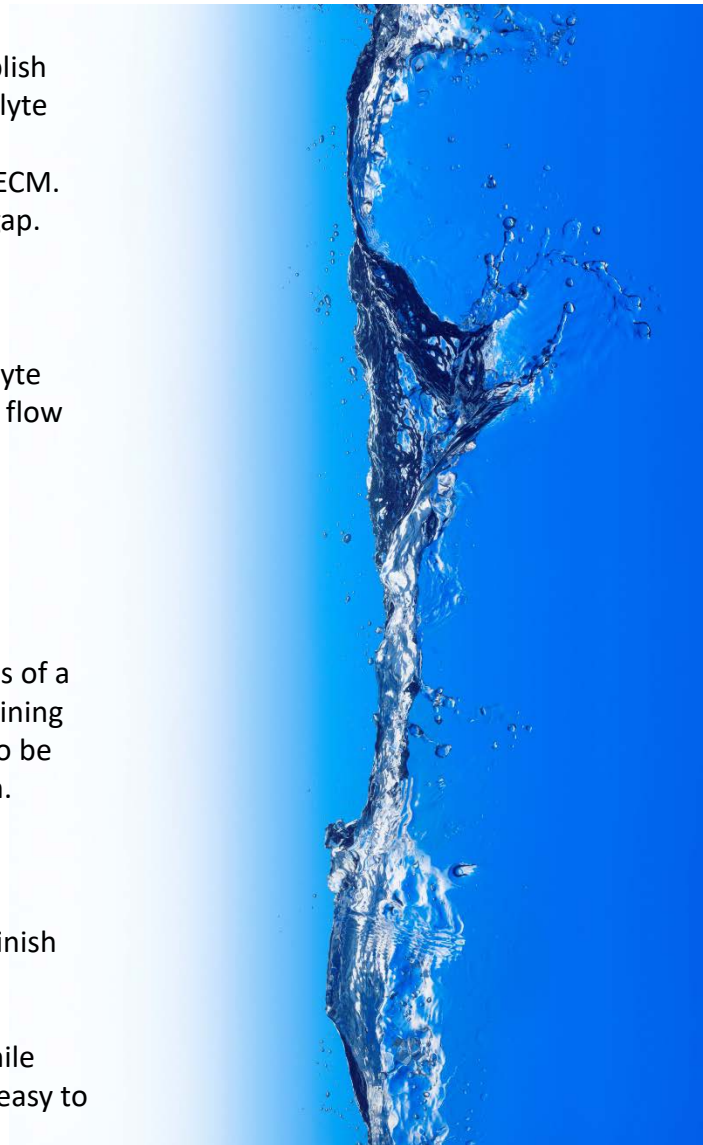



EXTRUDE  
HONE®

## Voltage pattern

In the ECM process, DC voltage can apply as constant, in pulses, or a combination of both.

Conventionally, constant DC voltage was the norm in ECM. Over time, it has changed to pulse voltage. Pulse voltage ensures that hydroxide is flushed away, and a clean electrolyte is present in the gap every time. The result is superior control over the ECM area and an improved surface finish.

Compared with conventional machining, constant voltage ECM is like roughing, although pulse is more like finishing. An optimum combination will be the solution in achieving the best cycle time and quality. In addition, the shape of the pulse has an excellent effect on the surface finish of the ECM area.

Precise voltage control is essential to achieve consistency in the ECM process.

■ Conventional processing with DC

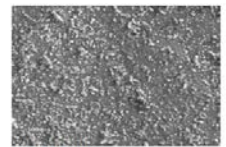
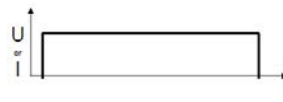

Rz=15 µm

■ Pulse-ECM with DC pulses

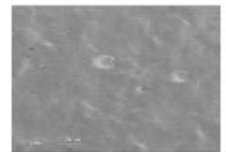
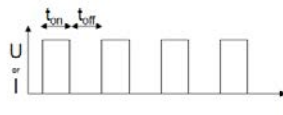

Rz=2 µm

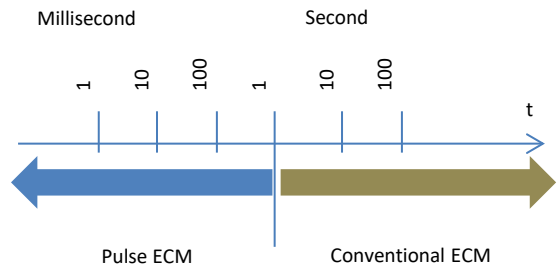

- When constant DC voltage gives high material removal rate, Pulse DC voltage generates a better surface finish.
- Often, both are combined in a two-step program to get the best of productivity & quality.





EXTRUDE  
HONE®

## Pre and Post ECM processing is critical

### Pre ECM processing

- Components must be clean, free of oil, loose burrs and foreign particles before feeding to the ECM process.
- Oil, a bad conductor of electricity, deters the ECM process. It also gets mixed with the electrolyte causing more harm to subsequent components.
- Loose burrs, if not washed properly, may cause a short circuit in the ECM process, damaging both cathodes and components.

### Post ECM processing

- ECM requires saltwater, a post ECM rinse in clean water is necessary to get rid of salt residue.
- For ferrous components, a rust preventive product is critical to prevent rust formation.
- Moreover, thorough hydroxides removal requires, at times, a more intensive cleaning system. Cleaning machines with dunking or/and ultrasonic agitation helps.







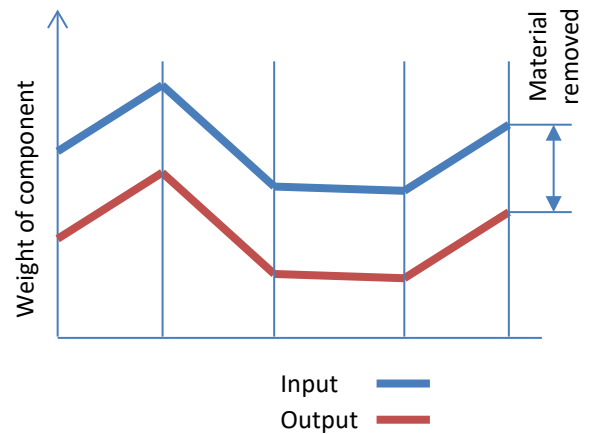

EXTRUDE  
HONE®

## Consistency in input condition

With all the controls in place, the ECM process can guarantee consistency in the amount of material removed in each cycle. The output correlates directly to the input components. For a static ECM application like deburring & edge radiusing, the incoming burr condition plays a critical role in the output quality. Hence, if the output edge condition comes with tight tolerances, the input condition must be uniform.



	The best case	The most probable case	The worst case
Input condition	 Burr free edge	 Moderate burr	 Large burr
Output condition	 The best of edge radius	 A relatively smaller edge radius	 A small portion of the burr is left out



EXTRUDE  
HONE®

## Impact of hole size and position in static ECM

In the ECM process, the cathode (tool) design and manufacturing require utmost accuracy & precision.

Any shift and size variation of the feature will result in variations in the output.

A perfect edge break radius at an intersected hole requires the hole size and positional accuracy to be closely maintained.

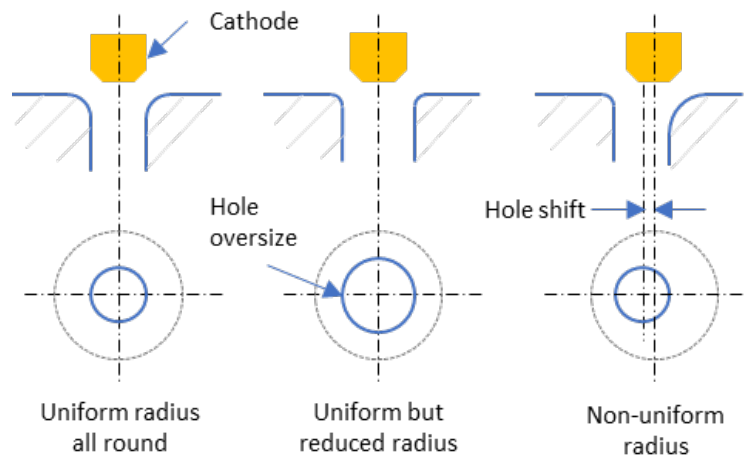



EXTRUDE  
HONE®

## ∫I dt control – an ultimate in ECM process consistency

Every operating parameter of a process should have a target. And for practical reasons, there should be lower and upper control limits.

ECM is no exception to that rule. All the critical parameters behave within control limits. The machine should have sensors to measure the parameters continuously. It should at least have an alarm if any factors go out of the limits. Best is an automatic control to maintain them within the operating range.

Even when the process is operating within limits, there are variations among components because of the influencing changing parameters. From the adjacent image, you can feel that the two components will not be similar when EC is machined even with the same voltage and for the same time.

∫I dt control becomes most useful here to precisely control the process outcome.

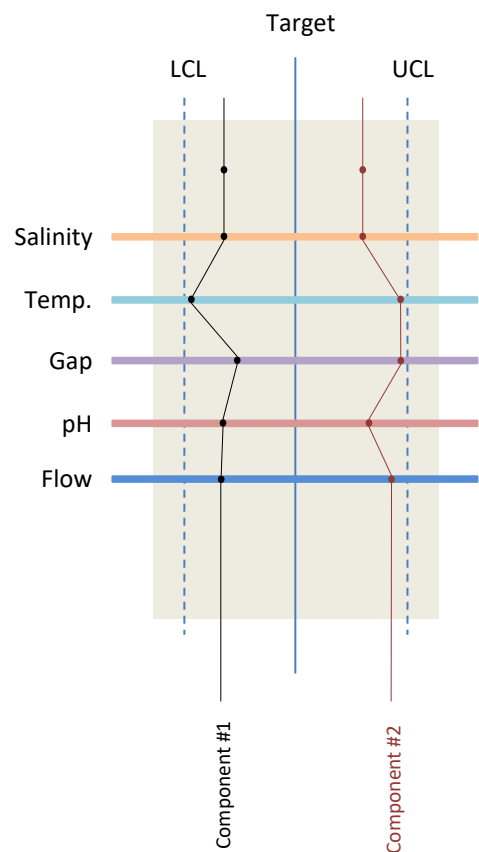



EXTRUDE  
HONE®

## Important features of an ECM machine

Feature	Benefits
Operator safety	In most cases, human operates ECM machine. ECM machines must have all safety features because they generate high currents and often have fixtures with moving parts.
Safety of the surroundings	ECM machines use salt water. And it causes corrosion even in vapor form. ECM machine should have its mechanism to minimize the spread of saltwater vapor.
Short circuit detection	<p>ECM process involves a DC power supply and electrodes of opposite polarity. If these electrodes come in contact, there will be a short circuit. High current flowing thru the electrodes could cause permanent damages. Accordingly, the machine must have the necessary electrical protection.</p> <p>Modern ECM machines come with a Short circuit detection feature. When a component seats in the fixture and cathodes come in machining positions, a small, pre-determined voltage applies to detect the presence of any short circuit. In the eventuality of a short circuit, the cycle aborts itself immediately with an alarm.</p>
Identification of Not-OK components	While processing a workpiece, if the ECM machine goes under out-of-control process parameters, the machine must trigger an alarm and identify the component as a potential faulty one.
Reduction of hexavalent chrome	<p>When high chromium (&gt; 5%) materials are EC machined, the ECM machine generates carcinogenic hexavalent chrome. Prolonged exposure causes irreparable damages to the respiratory system.</p> <p>A chrome reduction unit should be integrated into the ECM machine to reduce hexavalent chrome to trivalent chrome.</p>



EXTRUDE  
HONE®

## Tooling, the key element in ECM process

Tooling in the ECM process has a host of functions:

- Holding the component precisely as per design requirements and clamping it in position during machining.
- Guiding the electrolyte to & from the machining locations.
- Housing the cathodes and anode connections, connecting them electrically.

The chief decisions in tooling design are:

- Managing all the desired machining areas in minimum possible set-up.
- Accommodating multiple components in parallel if the product demand is high.

The design of tooling decides the ease of component loading and unloading, and the precision and accuracy in design and manufacturing ensure the accuracy and repeatability of ECM outcomes.

The choice of material used in manufacturing the tooling decides its life span.

Very often, interchangeability of tooling and quick change over is a requirement.

The most critical element in ECM tooling is Cathode which does electrochemical machining.

The cathodes carry electricity, and sometimes the electrolyte, to the machining area.

Its shape and manufacturing precision decide the ECM result. Cathodes may look simply.

Science is at the heart of cathode design and controls the dissolution of the material to achieve narrow tolerances in terms of geometry and roughness. The selection of base and insulation materials is the key to achieving superior performance and extended operating life.





EXTRUDE  
HONE®

# Equipment or Contract Shop, your choice

Extrude Hone supports customer in various markets in various ways:

## Feasibility – Testing

- Testing different technologies or a combination to find the perfect solution that suits their needs.

## Contract shops

- No need to invest - we have contract shops that can do the job for you.
- **Equipment**
- Want to keep the process a secret, bring machines to your location.
- The complete equipment portfolio is for sale. We will support you during ramp-up, and we will be beside you for service and consumables in the long term.





EXTRUDE  
HONE®

## Dynamic ECM

**Make the unthinkable possible with Dynamic Electrochemical Machining (D-ECM).**

Do you need to machine various patterns in an area that is out of reach by conventional means? We provide a high-accuracy, high-quality, and productive solution.

All this comes at an attractive cost per part.

In the illustration, we drill holes that conventional machining cannot achieve. The ECM cathode assembly goes down and then slides at a feed rate toward the workpiece center, machining the hole by dissolving the material.

Dynamic ECM is a modified ECM process in which the cathode moves constantly into the part. It provides finishing results for components with complex shapes that are difficult, if not impossible, to achieve with conventional machining methods.

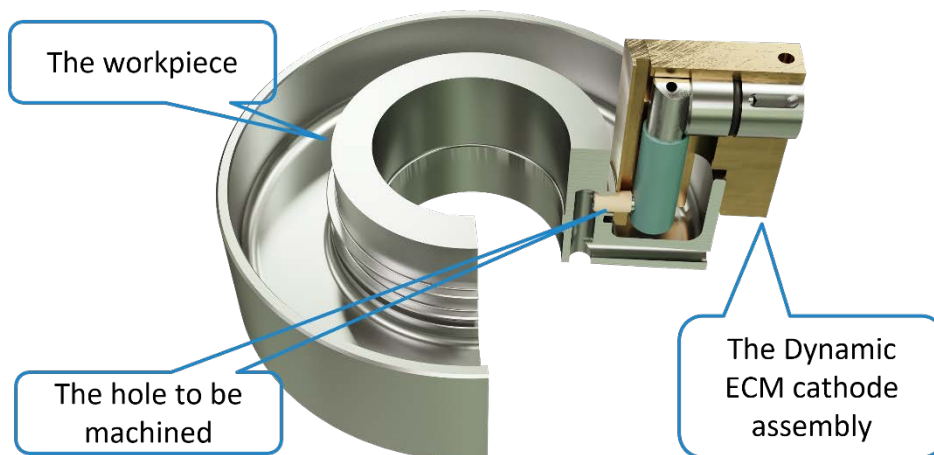





EXTRUDE  
HONE®

## Dynamic ECM

### How the Dynamic Electrochemical Machining Process Works:

Dynamic ECM consists of a drive axis and customized (part-specific) tooling.

The tool (cathode) is connected to the drive unit (axis) located on the upper part of the tooling.

Parameter input is controlled through the Operator interface and is stored under a part-specific file for repeatability.

The drive unit moves the cathode at a constant, controlled speed into the part.

Process control (parameter and short circuit control) ensures dimensional accuracy.

### Our Dynamic ECM Tooling Provides the Edge.

The tool (cathode) is a critical element of the Dynamic ECM process because its properties and shape determine where and how much material is removed from the workpiece. The tooling has no process-related wear because the cathode never encounters the workpiece.

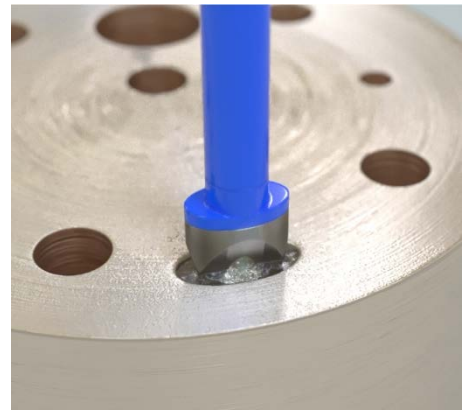



EXTRUDE  
HONE®

## EC Rifling principle

**EC Rifling is a winning alternative to the conventional rifling methods.**

Extrude Hone started EC Rifling in the late 80s, at that time as CATION Rifling. These machines are still in production & run in our Contract shop in Sterling Heights daily.

In 2024, we applied our know-how with the latest ECM Technology; the result is our latest generation EC Rifling system.

EC Rifling is typically applied in a vertical position. At the same time, the barrel (Anode) is in a fixed position, and the cathode moves with a combined vertical and rotational movement ( = TWIST ) through the part.

The cathode design requires a "Twist." The exposed metallic area (= active area) generates the groove, while the isolated area protects the land profile from being affected by the Process.

When looking at the EC rifling solution, the first thing that comes to my mind is that the non-contact feature between the cathode and the barrel sounds like a real game changer compared to conventional methods.

Let's clarify this. Traditional rifling means leverage methods based on cutting or deformation. Think about cut rifling, also called hook rifling, broach rifling, button rifling, and hammer forging.





EXTRUDE  
HONE®

## EC Rifling Benefits

### #1: Cold Stress-free Process:

ECM is a cold process where no stress is implied to the part. Using ECM for Barrel Rifling allows fewer processes into the process line as all activities toward Stress Relief fall apart.

### #2: Highest Flexibility:

ECM works independently from Material hardness as it dissolves & not cut or deform material - therefore, it is universal use for all types of metals, all incoming states Standard Rifling and Progressive Rifling & Progressive Depth Rifling can be done quickly by changing parameter settings.

### #3: Productivity:

ECM offers high productivity and feed rates (50 - 300mm/min). It also usually runs multiple parts per cycle simultaneously. Quick Changeover times from one type to the next one.

### #4: Accuracy & Process Stability

The Process follows Faraday's law & can easily be controlled to ensure consistent results from part to part. Tight tolerances can be held (Groove width 100 $\mu$ m, Groove depth 50 $\mu$ m) ECM combines Material removal & Surface finish within one step. Surface roughness after ECM is typically better than Ra 0,4 $\mu$ m

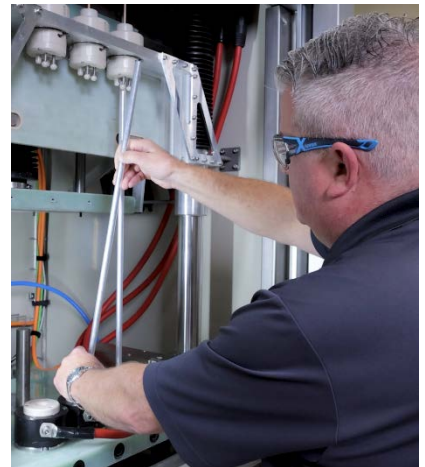



EXTRUDE  
HONE®

## ECM Micro Structuring

### Go beyond conventional machining!

Micro Structuring with Electrochemical Machining (ECM).

Need to machine various patterns, like radial and axial structures, internal or external.

In addition, you need to do it with high accuracy and repeatability.

It could be for compressors, heat pumps, refrigeration, air bearings, or clean gas applications.

We offer a solution that will deliver you productivity gains and attractive cost per part.

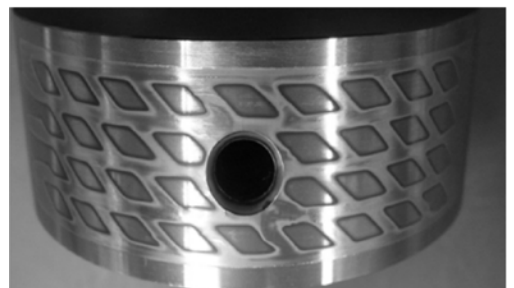



EXTRUDE  
HONE®

## Industry Experience

### Discover how customers leverage ECM





EXTRUDE  
HONE®

## Industry Experience

### Performance and safety meet with productivity

When you redefine the business jet travel experience with innovations in comfort, safety, and technology, that means you deserve the best.

Extrude Hone enables the highest quality hydraulics manifolds. Hydraulic manifolds are very demanding pieces of engineering and machining that contribute to smooth, precise and safe flights. There are no less than 248 areas in this aluminum manifold that Extrude Hone process using Electrochemical Machining (ECM). The applications ranged from simple deburring to intricate shapes with demanding tolerances. We do it all in 3 steps and a total of 15 minutes.

Cathodes dissolve burrs or the material in selected areas from the workpiece to create specific radius and shapes while also polishing the surface. The production fixture is quite complex and includes many cathodes. One cathode can process one or multiple areas within a bore. Cathode groups, each with a different current, are at work.

ECM ensures that all areas are processed and match the specification. It's much faster to use ECM than doing this by hand and much safer.

The geometries that ECM can do, true-radius, specific radii on round or oval forms, chamfer, finishing of thread ends, fine polishing of edges to protect seal during assembly.



© Dassault Aviation

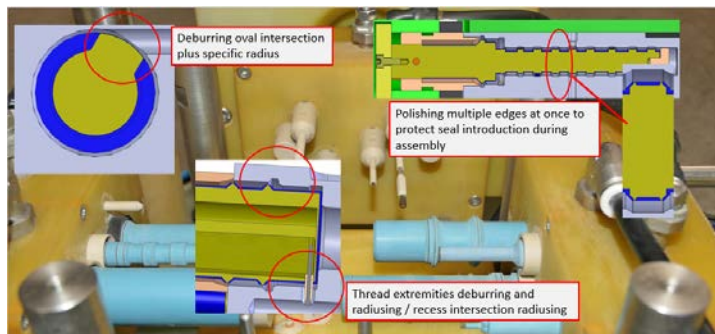
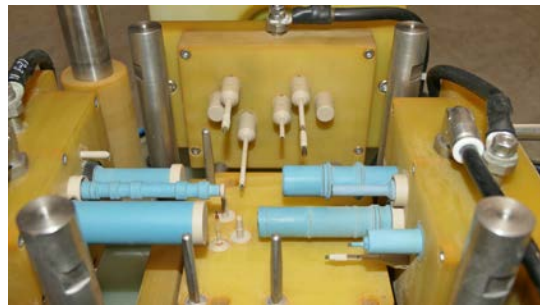



EXTRUDE  
HONE®

## Industry Experience

Mr. Gursharan Singh, Chairman and Managing Director at RACL Geartech Ltd. talks about adding Electrochemical Deburring to his gear manufacturing capabilities.

Predominantly our company is into the business of manufacturing gears, shafts & parts for automotive applications. You know, we are in this business for over 30 years and burrs presence has always remained a big challenge in manufacturing of the gears. By the way, not only RACL, but any other gear manufacturers will also confirm, that, historically burrs have always remained the problem.

Incidentally, our company started a new business relationship with ZF, Germany, for some critical applications for Ring Gears for Chassis applications, where we really faced a peculiar problem of burrs in Internal teeth, which was not accessible for any mechanical or manual deburring. The burr removal was a big problem by any conventional method. So, this is where ECM (Electrochemical Machining or Electrochemical deburring) came in.

We are quite enthusiastic about the overall results, which we have got so far. Extrude Hone gave us good technical support, achieved a timely delivery of the machine. There was a specific deadline requiring the machine to be dispatched by 31st of March. 31st of March the machine left Extrude Hone Germany, which reflects a strong commitment towards customer demands. That goes a long way.

In a process like Electrochemical Machining, there's always the need for frequent technical support, and the need of consistent supply of consumable supply like cathodes or other change over parts. It's a good initiative taken by Extrude Hone to have a facility in India. This goes without saying.



Source RACL Geartech Ltd



RACL Geartech Ltd.  
Formerly Raunaq Automotive Components Ltd.



Source RACL Geartech Ltd



EXTRUDE  
HONE®

## Industry Experience

Extrude Hone has been a ZF supplier of choice for ECM systems since 2006. Multiple components of an automatic gearbox benefit from the Electrochemical process.

In a planetary design transmission several components are likely to be ECM processed: sun wheel, output shaft, center gear, guide wheel shaft and planet gears.

In addition Thermal Deburring is used for simple deburring operation, to reduced burrs volume prior to ECM, or simply to eliminate all potential contaminants.

Quality of the gearing helps to reduce wear, vibration, friction and noise while reducing oil contamination. Superior automatic gearbox quality comes with perfect controlled edge breaks which ECM can performed with short time cycle contributing to high level productivity while fully integrated in production line.

May, 2020:

“Last year ZF and Extrude Hone agreed on several projects in order to streamline our product costs. Nowadays ZF is able to implement this technical cost savings in their shop floor, particularly regarding new transmission projects.

Many thanks to Extrude for their readiness and support!”

C. Hauser, Manager Corporate Material Management - ZF  
Commodity machine and equipment related tools



Source ZF







EXTRUDE  
HONE®

## Industry Experience

BURGMAIER HIGHTECH uses ECM to provide The Edge.

Radiusing & shaping solution for bore intersections at high-pressure areas of injector bodies. Absolute burr-free conditions by using ECM and thus achieves fatigue resistance in high-pressure components along with optimal efficiency due to enhanced flow properties.

The diesel fuel injection system is one of the core components of a diesel engine. It is responsible to supplying the right amount of fuel at exactly the right time.

Nowadays, where increasingly stringent emission standards force the manufacturers to lift the efficiency of their engines. Modern diesel engines, for example, are using pressures over 2000 bar to increase the efficiency of the

internal combustion. This also means immense stresses, especially on the bore intersections of the high-pressure area.

Tobias L., responsible for the ECM processes at BURGMAIER Hightech GmbH in Laupheim, gives us an insight to his daily work and how collaboration with Extrude Hone helps them to provide the edge: “I have joined BURGMAIER in 2004 as foreman for lines in the production. After several years of experiencing the ECM processes in our production I`m now responsible for maintenance of all the ECM equipment in our plant. Since we started using ECM at our facility in Laupheim we have always relied on the expertise and experience from Extrude Hone. This very close partnership starts with running feasibilities during the bidding phase in early project phases, finding and defining the perfect production process steps for ensuring best parts quality and cleanliness, and perfecting aftermarket service support with innovative ideas to optimize our processes and to lower our running costs.

We are an international manufacturer of precision parts. We have succeeded in both consolidating our position as a technology market leader and fulfilling the needs of our global customer base. Customer satisfaction is our top priority – we achieve it with the three pillars of our corporate culture: expertise, precision and reliability. With continuous improvement and by working closely with our customers, we aim to achieve technology and cost leadership.”

 BURGMAIER  
*Faszination durch Präzision*



iStock



## Industry Experience

Ventura use ECM for automotive braking system components.

Headquartered in Les Franqueses del Vallès in Spain and with facilities in Houston, USA and Suzhou, China, Ventura Precision Components is an expert in the supply of high-precision turned components for the automotive sector and for other market segments such as trucks, motorbikes and aeronautics.

With more than 45 years' experience, Ventura supplies components to leading Tier 1s such as Robert Bosch, Continental and TRW and prides itself in its ability to offer the highest quality components at competitive prices. Ventura's primary product line is pistons for brake system, and, in this market, they are worldwide leaders in the production of new generation pistons.

Ventura's success lies in no small part in its use of state-of-the-art equipment and production processes. One of these processes is electrochemical machining (ECM) and Extrude Hone is proud to support Ventura in delivering superior quality components to the end customers.

Electrochemical machining works on the principle of anodic metal dissolution and provides a high degree of precision on components that are difficult to manufacture and finish using conventional methods. Because ECM is a non-contact process, it does not subject the workpiece to mechanical or thermal stresses. This means no burrs/secondary burrs and no distortion of the workpiece, even on thin-walled aluminum components. ECM is very well suited for Ventura's high-volume production and offers great accuracy and a high degree of repeatability.

Ventura use ECM to deburr and radius cross-hole intersections on piston plungers (depicted in the image). It is critical that this area is free of burrs. A burr detaching from these cross holes could contaminate the brake's hydraulic system causing the system to seize or damage seals allowing hydraulic oil to leak and/or air to enter the system rendering the system ineffective.



Source Ventura



Source Ventura



EXTRUDE  
HONE®

## Experience Extrude Hone Now!

Discover more Technologies, Applications through detailed 3D animations and Customer Testimonials.  
Visit our Virtual Booth.



Focus on 6 Industries - Available in 6 languages

[www.vb.extrudehone.com](http://www.vb.extrudehone.com)

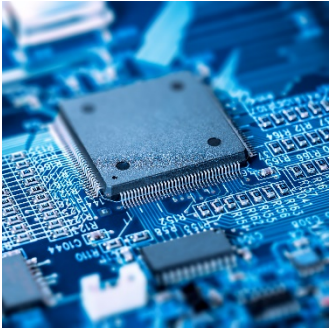

**EXTRUDE HONE®**  
**SHAPING YOUR FUTURE**

